

**zehnder**

always the  
best climate

# Zehnder ComfoAir Q600 ST

Technical specification for comfort ventilation unit



## General

Whether you are working on a new build or a renovation project: With a maximum air volume flow of 600 m<sup>3</sup>/h at an external pressure of 200 Pa, the Zehnder ComfoAir Q600 ST comfort ventilation unit is flexibly suitable for single-family houses and apartment buildings, offices and commercial buildings. With its new technologies, starting with the diamond heat exchanger, through the revolutionary fan technology for a modulating by-pass and the optional adaptive pre-heater, combined with state-of-the-art control system technology like flow control and active comfort control and a user-friendly operating concept from simple switches to apps, Zehnder ComfoAir Q is a guarantee for a comfortable, healthy and energy-efficient indoor climate.



Zehnder ComfoAir Q600 ST

\* Depending on the control unit/sensor technology chosen.  
Detailed information on page 11 and at [international.zehnder-systems.com](http://international.zehnder-systems.com)



Zehnder  
ComfoSense C55



Zehnder  
ComfoSwitch C55



Zehnder  
ComfoControl

## Benefits

- More heat recovery and less power consumption because of the diamond heat exchanger with a larger surface and lower pressure losses
- Silent and efficient operation via the latest fan technology with RadiCal impeller, flow ring and flow grid
- More comfort via optimal supply temperature via the modulating by-pass with an intelligent temperature controller
- Energy-saving and demand-oriented tempering of outdoor air via adaptive pre-heater (optional)
- Security for planning and installation as one unit combines right and left version
- Simple commissioning and quiet operation with perfectly balanced volume flows because of flow control technology
- User-friendly operation via the tailored operating concept: from an intelligent switch to the app
- Hygienic because of optimal filter concept with filter change wizard
- Avoidance of excessively dry room air because of humidity recovery with the Zehnder enthalpy exchanger (optional)

## Technical specifications

Zehnder ComfoAir Q600 ST	
Max. air volume	600 m <sup>3</sup> /h
Height	809 mm
Total height	850 mm
Width	725 mm
Overall width	790 mm
Depth	570 mm
Total depth	580 mm / 595 mm
Weight	50 kg
Installation	Wall-mounted / floor-mounted
Temperature range	+7 °C to 40 °C in the installation room
Condensate drain	32 mm / DN 32 external thread
Nominal size of drain connection	180 / 200 mm
Supply voltage	230 V, 50 Hz
Power consumption without/with VEW	350 W / 2,620 W
Current draw without/with VEW	2.77 A / 12.7 A
Cos φ	0.40–0.62
Protection class	IP40
Housing	Sheet steel
Designer front panel	ABS, RAL 9003
Inner zone	EPP / ABS
Heat exchanger	PS
Enthalpy exchanger	PE-Copolymer



## Energy figures

DIBt (preliminary data)		
Product	Zehnder ComfoAir Q600 ST	ComfoAir Q600 ST enthalpy
Approval number	Pending (file number III58-1.51.3-30/16)	Pending (file number III58-1.51.3-30/16)
Extract air volume flow $V_{ab}$ [m <sup>3</sup> /h]	$50 \leq V_{ab} \leq 600^*$	$50 \leq V_{ab} \leq 600^*$
Heat recovery efficiency $\eta_{WRG}$ [-]	90%*	77%*
Specific electric power consumption $p_{el}$ [W/(m <sup>3</sup> /h)]	0.24*	0.22*

### "Passivhaus" certification

Component ID	0975vs03	1008vs03
Application [m <sup>3</sup> /h]	70-460	70-460
Heat recovery efficiency $\eta_{WRG}$ [-]	87%	80%
Specific electric power consumption $p_{el,spec}$ [W/(m <sup>3</sup> /h)]	0.24	0.22
Humidity recovery $\eta_X$ [-]	-	68%

### EU Energy Consumption Label

Energy efficiency class		
Maximum air volume flow [m <sup>3</sup> /h]	600	600
Sound power level $L_{WA}$ [dB]	51	51

\* uncorrected manufacturer's specifications

\*\* depending on the control unit/sensor technology chosen.

## Article numbers

ST = connections on top; Enthalpy = enthalpy exchanger

Comfort ventilation unit	Article number
ComfoAir Q600 ST	471 502 114
ComfoAir Q600 ST enthalpy	471 502 115

Accessories	Article number
ComfoAir Q350/450/600 pre-heater	400 502 007
ComfoAir Q350/450/600 mounting base	471 502 008
Dry siphon 5/4"	990 201 330
Enthalpy exchanger for ComfoAir Q350/450/600	527 006 990

Filters	Article number
Filter set for ComfoAir Q350/450/600, G4 / G4 (contains 2 units)	400 502 012
Filter set for ComfoAir Q350/450/600, G4 / G7 (contains 2 units)	400 502 013
Filter set for ComfoAir Q350/450/600, G4 / G4 (contains 10 units)	400 502 014
Filter set for ComfoAir Q350/450/600, G4 / G7 (contains 10 units)	400 502 015

Control units	Article number
ComfoSense C55 control panel	655 010 225
ComfoSense C67 control panel	655 010 235
ComfoSwitch C55 control panel	655 010 245
ComfoSwitch C67 control panel	655 010 255
ComfoConnect LAN C interface	655 011 100
ComfoConnect KNX C interface	655 011 120
ComfoAir Q350/450/600 option box	471 502 007
CO <sub>2</sub> sensor	659 000 340
Humidity sensor	659 000 330
Remote-controlled control panel*	655 000 755
ComfoSplitter	655 010 270

\* only in conjunction with a ComfoSense C control panel

System expansions	Article number
Zehnder ComfoFond-L Q L ST brine-earth heat exchanger, supply air connection left	471 310 084
Zehnder ComfoFond-L Q R ST brine-earth heat exchanger, supply air connection right	471 310 085
Zehnder ComfoCool Q600 L ST air tempering unit with supply connector on left	471 410 005
Zehnder ComfoCool Q600 R ST air tempering unit with supply connector on right	471 410 006

## Technologies

### Diamond heat exchanger



Unique, ultra-powerful heat exchanger – for maximum energy efficiency

The Paul diamond heat exchanger features an especially large surface, which allows it to achieve a higher level of efficiency. Variable duct heights ensure even flow and lower pressure losses, and thus optimal airflow. As a result, less energy is required to overcome the air resistance.

### Fans

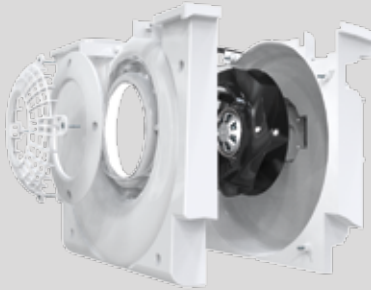

State-of-the-art fan technology – for quiet, energy-saving operation

The flow grid, scroll housing and ebm-papst RadiCal impeller ensure the best possible air flow. This guarantees not only extremely quiet operation, but also particularly low power consumption. A high-quality, future-proof solution, based on tried-and-tested technology.

### Modulating by-pass

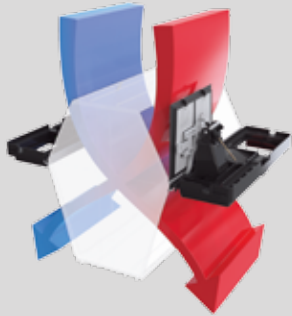

Comfortable indoor ventilation because of intelligent control of the heat recovery

The by-pass controls the exact degree of heat recovery and influences the supply air temperature as a result. The modulating by-pass is guided by an optimum comfort temperature, which is determined on the basis of information from the temperature and humidity sensors as well as an intelligent algorithm.

### Pre-heater

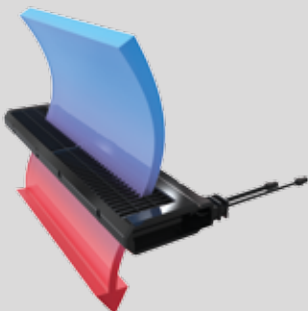

Intelligent temperature control of the drawn-in outdoor air for the best possible energy efficiency

The adaptive pre-heater adapts perfectly to the temperature, volume flow and air humidity, and provides the outside air temperature required for energy-efficient operation no matter what the temperatures are outside. The level of pressure loss is negligible because of its large surface and delta shape – and that also reduces the power consumption.

## Sensors

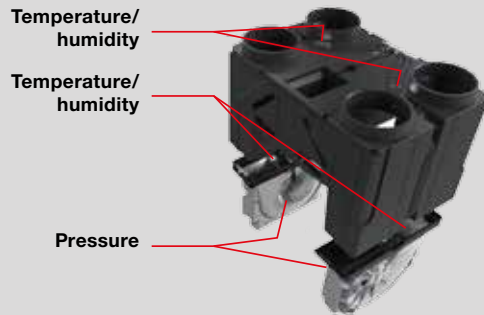

Flawless operation because of intelligent control

Individual sensors continuously determine the temperature, humidity and air pressure in the comfort ventilation unit. This permits precise control of the modulating by-pass, the pre-heater, flow control and humidity comfort mode. The sensors permit precise control of the ventilation unit for a perfect feel-good climate.

## Comfort temperature

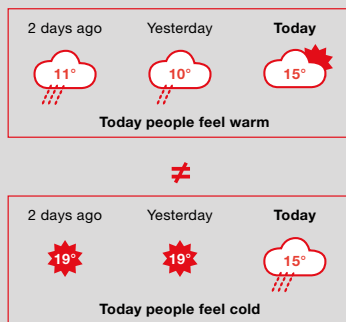

Ideal supply air temperature because of comfort technology

People's temperature sensation depends on the current outdoor temperature and the average outdoor temperatures experienced recently. For this reason, the adaptive climate technology in Zehnder ComfoAir Q adapts the supply air temperature to suit their current needs. As a result, Zehnder ventilation units make an important contribution to ensuring a comfortable indoor climate throughout the year – benefiting your customers.

## Filters

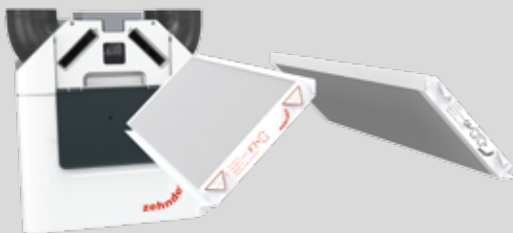

Optimum hygiene because of powerful filters

Completely sealed and maximised, the filters prevent dust from getting into the room air. There is also a warning indicator to show when it is time to replace the filters, ensuring the air is always clean and healthy. The indicator factors in not only the elapsed time, but also the air volume transported.

## Flow control



Innovative air volume balancing for maximum heat recovery

New and patented: innovative sensor technology automatically ensures balanced supply air and extract air volumes. This flow control guarantees maximum heat recovery. What's more, you save time during commissioning because there is no need to adjust the speed manually and the air volumes are balanced automatically.

## Control options

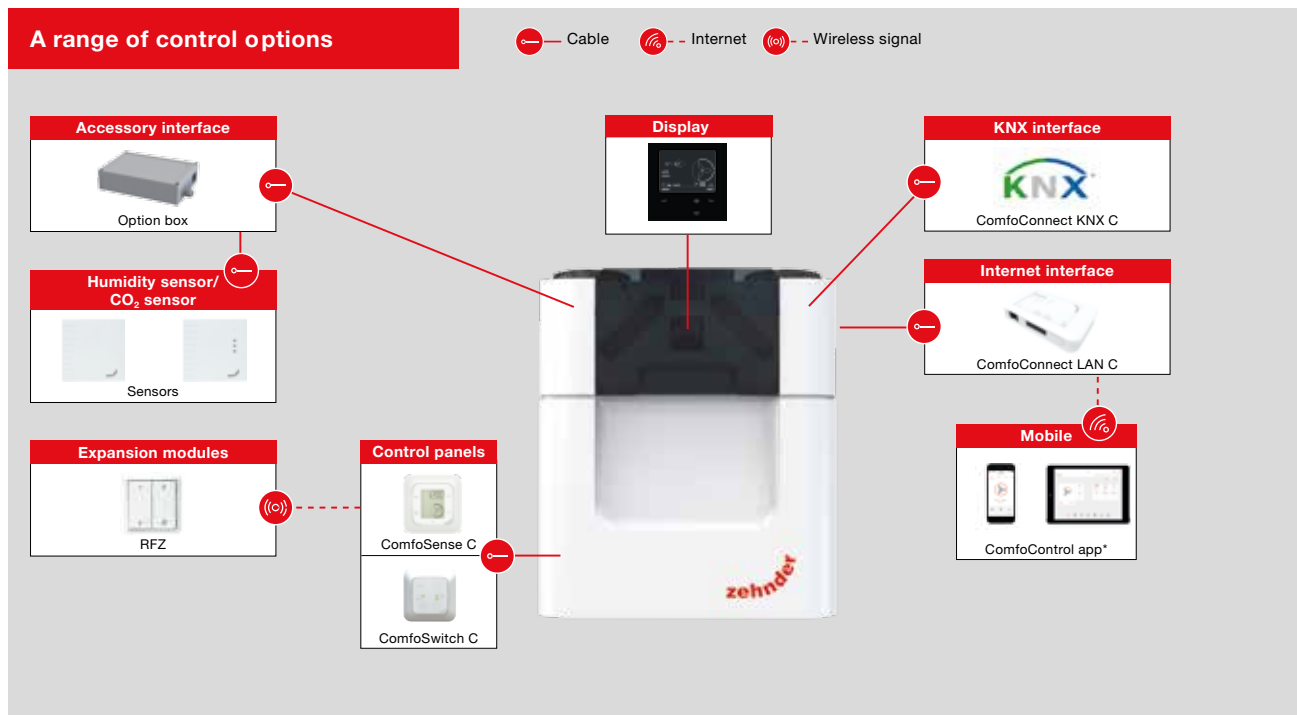

Control panel	Description	Article number	Accessories required
Unit display	Display integrated ex works	-	-
External control panels	ComfoSense C55 control panel ComfoSense C67 control panel ComfoSwitch C55 control panel ComfoSwitch C67 control panel	655 010 225 655 010 235 655 010 245 655 010 255	-
Wireless remote control	Wireless remote control RF	655 000 755	ComfoSense C control panel
Sensor (wired, 0 - 10 V control output)	CO <sub>2</sub> sensor Humidity sensor	659 000 340 659 000 330	Option box
App control and web portal**	ComfoConnect LAN C interface	655 011 100	Internet access + router with WiFi access
Connection to KNX network	ComfoConnect KNX C interface	655 011 120	

All components can be combined with one another. If there are more than four components, a Zehnder ComfoSplitter is required.

\* Internet access and a router with WiFi access are required for connection

## Control functions

### Comfort ventilation unit

- Commissioning wizard
- Filter change wizard
- Real time information for energy saving/consumption
- Adaptive comfort temperature control
- Flow control technology, constant volume and constant speed control
- 4 levels, party and absence settings
- Weekly time schedule
- Control for a modulating electric preheater
- Supply and extract air can be set and deactivated separately
- Frost protection function
- Programme setting: fire place
- ComfoCool Q600 control (Q600 only)

### Option box

- Control for ComfoFond-L Q brine-earth heat exchanger
- Power-on and power-off delay for bathroom switch
- Control for re-heater 0-10 V
- Demand control (CO<sub>2</sub> sensor, humidity sensor)

## Tender specification

### Zehnder ComfoAir Q600 ST ventilation unit with integrated display

The Zehnder ComfoAir Q600 ST is a centralised, compact ventilation unit with heat recovery and integrated adaptive summer by-pass. This ventilation unit is ideal for new builds as well as for renovation projects.

The housing, made of galvanised or painted sheet steel, is acoustically and thermally insulated. Economical DC fans with RadiCal impeller, flow ring and flow grid ensure economical operation and therefore permit a high level of electrical efficiency. Supply and extraction fans can be controlled separately and can be precisely adjusted to within one percent by entering the balance air volume.

The core of Zehnder ComfoAir Q600 ST is the plastic cross-counterflow heat exchanger with up to 95% heat recovery. It is operated via the integrated control panel. Optionally, it can be operated via a wired control panel (ComfoSense C or ComfoSwitch C), which is connected to the ventilation unit with a cable provided on site (JYSTY 2x2x0.6). It can also be operated via the Zehnder ComfoConnect LAN C or ComfoConnect KNX C interfaces. All working conditions and error messages can be read from the display.

Zehnder ComfoAir Q600 ST is delivered ready to plug in and use. The filters can be replaced easily from the front by the user without opening the unit. The Zehnder ComfoAir Q600 ST can be either wall-mounted or floor-mounted with an optionally available base. It is connected via 4 x DN 180 pipe connections at the top of the unit.

- Automatic frost protection regulation - Filter replacement display
- G4/F7 filters
- Automatic and temperature-controlled by-pass
- Fault history including the last three error messages
- Supply and extraction fans can be activated separately
- Comfort temperature controller
- Programme setting: fire place
- Heat exchanger: PE-Copolymer
- Fans: EC DC fans, radial, suction side
- Filter:
  - Extract air: G4
  - Outdoor air: F7
- Condensate drain: DN 32
- Air duct connections: 4x DN180 on top
- Mains power supply: 230 V, 50 Hz
- Temperature range: 7 °C to 40 °C in the installation room
- Sound power (min./max.):
  - Extract air: 43.0 dB(A) / 61.0 dB(A)
  - Supply air: 54.0 dB(A) / 75.0 dB(A)
- Waste heat recovery efficiency: up to 90%
- Volume flow:
  - max. 600 m<sup>3</sup>/h at 200 Pa external
  - min. 40 m<sup>3</sup>/h at 10 Pa external
- Power consumption:
  - Maximum 345 watt
- Electrical efficiency:
  - 0.26 Wh/m<sup>3</sup> at 420 m<sup>3</sup>/h
- Dimensions:
  - Height: with connector 850 mm
  - Width: with connector 725 mm
  - Depth: 570 mm
- Type: ZE ComfoAir Q600 ST ventilation unit with integrated display
- Brand: Zehnder Comfosystems
- Article number: 471 502 114

## Sound specifications

### Sound, pressure side (supply air/exhaust air)\*

Measurement point	[m <sup>3</sup> /h]	[Pa]	63 Hz [dB]	125 Hz [dB]	250 Hz [dB]	500 Hz [dB]	1,000 Hz [dB]	2,000 Hz [dB]	4,000 Hz [dB]	8,000 Hz [dB]	Total [dB(A)]
1	250	25	62.7	57.7	58.4	50.9	46.1	43.1	35.7	24.9	53.9
2	300	25	64.4	59.4	60.6	53.7	48.5	45.9	39.3	29.2	56.4
3	350	50	66.6	61.6	63.5	57.2	51.5	49.3	43.8	34.4	59.5
4	400	50	68.3	63.3	65.7	60.0	53.9	52.1	47.3	38.6	62.0
5	420	50	69.0	64.0	66.6	61.1	54.8	53.2	48.8	40.3	63.0
6	450	100	70.6	65.6	68.8	63.8	57.2	55.9	52.2	44.4	65.5
7	500	100	72.3	67.3	71.0	66.5	59.5	58.6	55.7	48.6	68.1
8	600	100	75.8	70.8	75.6	72.1	64.3	64.2	62.9	57.0	73.5
9	450	150	71.2	66.2	69.6	64.8	58.0	56.9	53.5	45.9	66.4
10	450	200	71.8	66.8	70.4	65.7	58.8	57.8	54.7	47.4	67.4
11	500	200	73.4	68.4	72.5	68.3	61.0	60.4	58.0	51.2	69.8
12	600	200	67.7	71.7	76.8	73.6	65.6	65.6	64.8	59.3	74.9

### Sound, suction side (extract air/outdoor air)\*

Measurement point	[m <sup>3</sup> /h]	[Pa]	63 Hz [dB]	125 Hz [dB]	250 Hz [dB]	500 Hz [dB]	1,000 Hz [dB]	2,000 Hz [dB]	4,000 Hz [dB]	8,000 Hz [dB]	Total [dB(A)]
1	250	25	56.1	51.1	48.9	38.8	31.7	27.4	21.2	19.4	43.2
2	300	25	58.0	53.0	50.8	41.5	33.6	29.5	23.7	20.5	45.3
3	350	50	60.3	55.3	53.2	44.8	36.1	32.1	26.8	21.9	47.8
4	400	50	62.2	57.2	55.1	47.4	38.0	34.1	29.3	23.0	49.9
5	420	50	63.0	58.0	55.8	48.5	38.8	35.0	30.3	23.4	50.8
6	450	100	64.8	59.8	57.7	51.0	40.7	37.0	32.7	24.5	52.8
7	500	100	66.7	61.7	59.5	53.6	42.6	39.0	35.1	25.5	55.0
8	600	100	70.5	65.5	63.3	59.0	46.5	43.2	40.2	27.7	59.4
9	450	150	65.5	60.5	58.3	52.0	41.4	37.7	33.6	24.8	53.6
10	450	200	66.1	61.1	59.0	52.9	42.0	38.4	34.4	25.2	54.4
11	500	200	67.9	62.9	60.7	55.3	43.8	40.3	36.7	26.2	56.4
12	600	200	71.5	66.5	64.3	60.3	47.5	44.3	41.5	28.3	60.6

### Housing radiation, installation room\*

Measurement point	[m <sup>3</sup> /h]	[Pa]	63 Hz [dB]	125 Hz [dB]	250 Hz [dB]	500 Hz [dB]	1,000 Hz [dB]	2,000 Hz [dB]	4,000 Hz [dB]	8,000 Hz [dB]	Total [dB(A)]
1	250	25	52.0	47.0	47.6	40.9	36.0	31.5	24.9	20.1	43.4
2	300	25	53.2	48.2	49.3	43.3	37.9	34.0	28.1	22.9	45.4
3	350	50	54.8	49.8	51.4	46.2	40.4	37.2	32.1	26.3	48.0
4	400	50	56.1	51.1	53.0	48.6	42.4	39.7	35.4	29.1	50.0
5	420	50	56.6	51.6	53.7	49.6	43.2	40.7	36.7	30.2	50.9
6	450	100	57.9	52.9	55.3	51.8	45.1	43.2	39.8	32.9	53.0
7	500	100	59.1	54.1	56.9	54.1	47.0	45.7	43.0	35.7	55.2
8	600	100	61.7	56.7	60.2	58.9	51.0	50.8	49.5	41.3	59.7
9	450	150	58.3	53.3	55.9	52.6	45.8	44.1	40.9	33.9	53.8
10	450	200	58.8	53.8	56.5	53.5	46.5	45.0	42.1	34.9	54.5
11	500	200	60.0	55.0	58.0	55.6	48.3	47.3	45.0	37.4	56.6
12	600	200	62.4	57.4	61.1	60.1	52.0	52.2	51.2	42.7	60.9

\* Housing radiation measured per ISO 3741:2010

Noise, suction side/pressure side, measured per ISO 5135:1997

Lw in dB(A) at reference area 10<sup>-12</sup>W



## Performance data

Performance data*								
Measurement point	[m <sup>3</sup> /h]	[Pa]	P [W]	cos φ	SFP [Wh/m <sup>3</sup> ]	Lw, pressure side [dB(A)]	Lw, suction side [dB(A)]	Lw, housing [dB(A)]
1	250	25	28	0.48	0.11	53.9	43.2	43.4
2	300	25	44	0.51	0.15	56.4	45.3	45.4
3	350	50	72	0.54	0.21	59.5	47.8	48.0
4	400	50	97	0.55	0.24	62.0	49.9	50.0
5	420	50	108	0.56	0.26	63.0	50.8	50.9
6	450	100	144	0.57	0.32	65.5	52.8	53.0
7	500	100	177	0.59	0.35	68.1	55.0	55.2
8	600	100	255	0.61	0.43	73.5	59.4	59.7
9	450	150	163	0.58	0.36	66.4	53.6	53.8
10	450	200	182	0.59	0.40	67.4	54.4	54.5
11	500	200	217	0.60	0.43	69.8	56.4	56.6
12	600	200	298	0.62	0.50	74.9	60.3	60.9

\* SFP in Wh/m<sup>3</sup> calculated per EN13141-7:2010  
cos phi with pre-heater deactivated

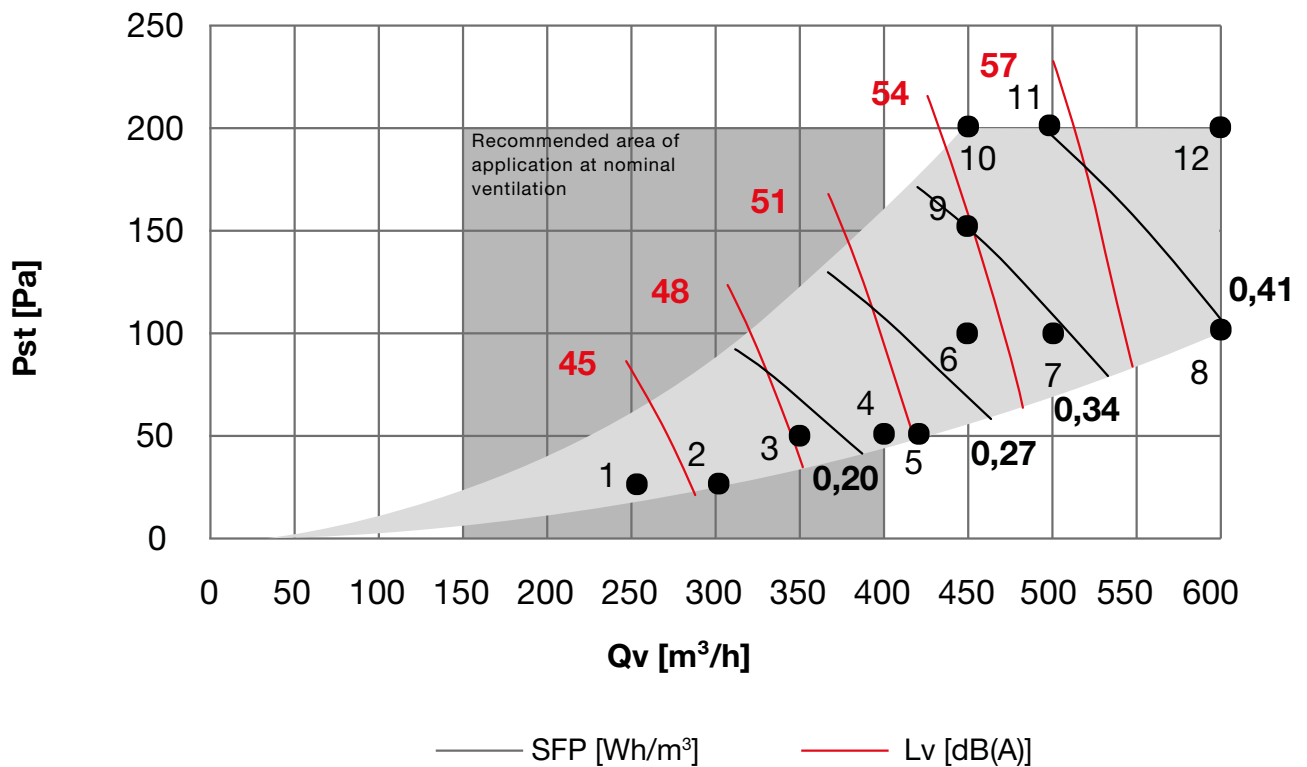

## Dimensional drawings

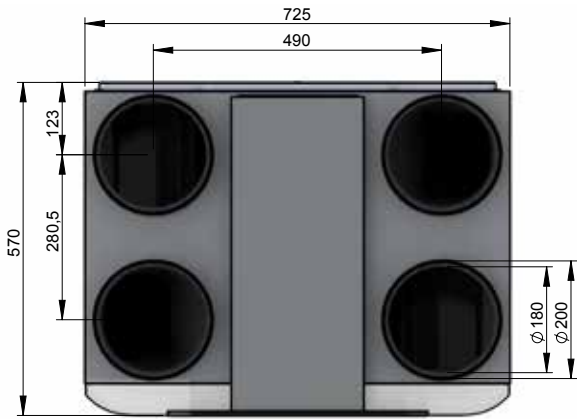

Top



Front

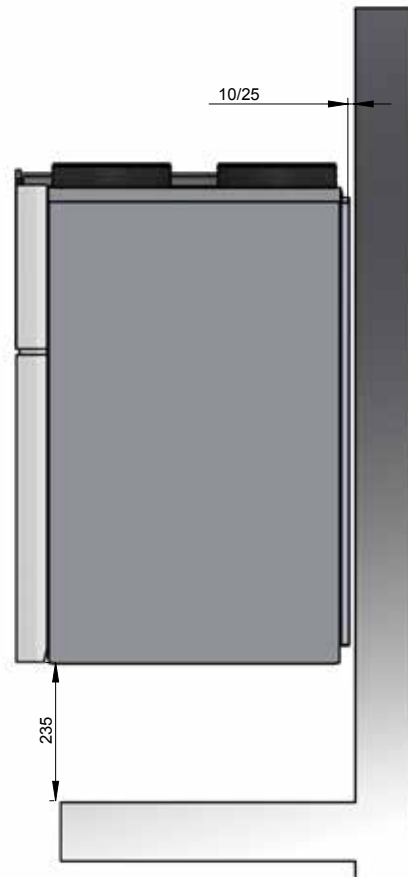

Side

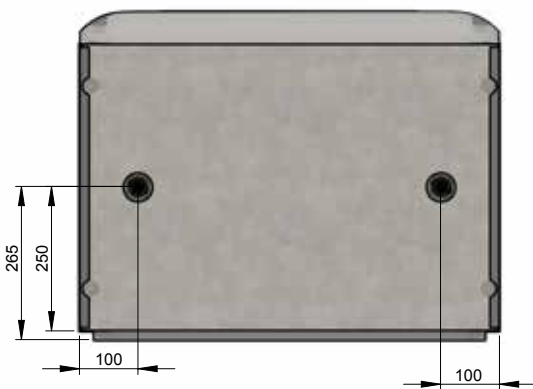

Bottom

## Air directions

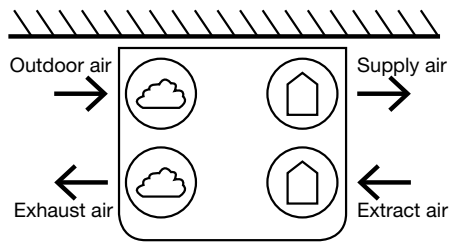

Supply and extract air to right

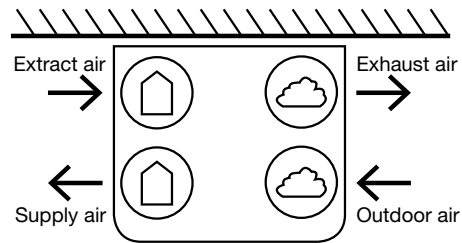

Supply and extract air to left

## Energy efficiency classes

Energy efficiency classes in accordance with EU Regulation no. 1254/2014.

### Energy efficiency classes

	Article number	Control according to site requirements	Central demand control	Time control	Manual control
		Option Box 471 502 007 +			
		2 x CO <sub>2</sub> sensor 659 000 340	No further accessories	No further accessories	No further accessories
		1 x CO <sub>2</sub> sensor 659 000 340 and 1 x humidity sensor 659 000 330			
		2 x humidity sensor 659 000 330			
ComfoAir Q600 ST	471 502 112	<b>A<sup>+</sup></b>	<b>A</b>	<b>A</b>	<b>A</b>
ComfoAir Q600 ST enthalpy	471 502 113	<b>A</b>	<b>A</b>	<b>B</b>	<b>B</b>

Release data: 25/01/2017

Information requirement for RVUs as per EU Regulation No. 1254/2014												
Heat recovery unit Zehnder ComfoAir Q600												
Supplier's name or trade mark	Zehnder Group			Zehnder Group			Zehnder Group			Zehnder Group		
Supplier's model identifier	ComfoAir Q600			ComfoAir Q600			ComfoAir Q600			ComfoAir Q600		
SEC [kWh/(m <sup>2</sup> a)] specific energy consumption (cold, average, warm)	-75,7	-37,2	-12,6	-76,6	-38,0	-13,3	-78,9	-40,0	-15,1	-82,6	-43,0	-17,8
SEC Class	A+	A	E	A+	A	E	A+	A	E	A+	A+	E
Type of ventilation unit	Bidirectional RVU			Bidirectional RVU			Bidirectional RVU			Bidirectional RVU		
Type of drive installed	Multi-speed drive			Multi-speed drive			Variable speed drive			Variable speed drive		
Type of heat recovery system	Recuperative			Recuperative			Recuperative			Recuperative		
Thermal efficiency [%]	90			90			90			90		
Maximum flow rate [m <sup>3</sup> /h]	600			600			600			600		
Electric power input [W]	345			345			345			345		
Sound power level [dB(A)]	51			51			51			51		
Reference flow rate [m <sup>3</sup> /h]	420			420			420			420		
Reference pressure difference [Pa]	50			50			50			50		
SPI [W/(m <sup>3</sup> /h)]	0,26			0,26			0,26			0,26		
Control factor and typology	1 Manual control			0,95 Clock-controlled			0,85 Central demand control			0,65 Local demand control		
Declared maximum internal and external leakage rates [%]	Internal: 0,6			Internal: 0,6			Internal: 0,6			Internal: 0,6		
	External: 1,1			External: 1,1			External: 1,1			External: 1,1		
Mixing rate	-			-			-			-		
Position and description of visual filter warning	Warning on the display of the unit or room controller			Warning on the display of the unit or room controller			Warning on the display of the unit or room controller			Warning on the display of the unit or room controller		
Internet address for assembly and disassembly instructions	www.international.zehnder-systems.com			www.international.zehnder-systems.com			www.international.zehnder-systems.com			www.international.zehnder-systems.com		
Airflow sensitivity to pressure variations [%]	-			-			-			-		
Indoor/outdoor air tightness [m <sup>3</sup> /h]	-			-			-			-		
AEC [kWh/a] annual electricity consumption (cold, average, warm)	908	371	326	884	347	302	817	280	235	720	183	138
AHS [kWh/a] annual heating energy saved (cold, average, warm)	8963	4582	2072	8995	4598	2079	9057	4630	2094	9182	4693	2122

<b>Information requirement for RVUs as per EU Regulation No. 1254/2014</b>												
<b>Heat recovery unit Zehnder ComfoAir Q600 ERV</b>												
<b>Supplier's name or trade mark</b>	Zehnder Group			Zehnder Group			Zehnder Group			Zehnder Group		
<b>Supplier's model identifier</b>	ComfoAir Q600 ERV			ComfoAir Q600 ERV			ComfoAir Q600 ERV			ComfoAir Q600 ERV		
<b>SEC [kWh/(m<sup>2</sup>a)] specific energy consumption (cold, average, warm)</b>	-66,9	-32,8	-10,6	-68,3	-33,8	-11,3	-71,5	-36,2	-13,3	-76,9	-40,1	-16,5
<b>SEC Class</b>	A+	B	E	A+	B	E	A+	A	E	A+	A	E
<b>Type of ventilation unit</b>	Bidirectional RVU			Bidirectional RVU			Bidirectional RVU			Bidirectional RVU		
<b>Type of drive installed</b>	Multi-speed drive			Multi-speed drive			Variable speed drive			Variable speed drive		
<b>Type of heat recovery system</b>	Recuperative			Recuperative			Recuperative			Recuperative		
<b>Thermal efficiency [%]</b>	76			76			76			76		
<b>Maximum flow rate [m<sup>3</sup>/h]</b>	600			600			600			600		
<b>Electric power input [W]</b>	345			345			345			345		
<b>Sound power level [dB(A)]</b>	51			51			51			51		
<b>Reference flow rate [m<sup>3</sup>/h]</b>	420			420			420			420		
<b>Reference pressure difference [Pa]</b>	50			50			50			50		
<b>SPI [W/(m<sup>3</sup>/h)]</b>	0,26			0,26			0,26			0,26		
<b>Control factor and typology</b>	1 Manual control			0,95 Clock-controlled			0,85 Central demand control			0,65 Local demand control		
<b>Declared maximum internal and external leakage rates [%]</b>	Internal: 1,6			Internal: 1,6			Internal: 1,6			Internal: 1,6		
	External: 1,1			External: 1,1			External: 1,1			External: 1,1		
<b>Mixing rate</b>	-			-			-			-		
<b>Position and description of visual filter warning</b>	Warning on the display of the unit or room controller			Warning on the display of the unit or room controller			Warning on the display of the unit or room controller			Warning on the display of the unit or room controller		
<b>Internet address for assembly and disassembly instructions</b>	www.international.zehnder-systems.com			www.international.zehnder-systems.com			www.international.zehnder-systems.com			www.international.zehnder-systems.com		
<b>Airflow sensitivity to pressure variations [%]</b>	-			-			-			-		
<b>Indoor/outdoor air tightness [m<sup>3</sup>/h]</b>	-			-			-			-		
<b>AEC [kWh/a] annual electricity consumption (cold, average, warm)</b>	908	371	326	884	347	302	817	280	235	720	183	138
<b>AHS [kWh/a] annual heating energy saved (cold, average, warm)</b>	8091	4136	1870	8166	4174	1888	8315	4251	1922	8615	4404	1991

Z\_SI\_V0317\_CSX\_TES\_TS137, en, subject to change without notice